

- General Purpose IEPE Accelerometer
- Shear design
- Piezoelectric ceramic PZT-5
- Sensitivity – 10mV/g
- Mass – 5.8grams
- 10-32UNF side entry connector
- 10-32UNF Tapped base

The GV10S-T is a general purpose monoaxial IEPE accelerometer with a side entry 10/32UNF microdot connector and a tapped base for stud mounting. Featuring a shear design PZT-5 sensing element the GV10S-T is widely used a control accelerometer for vibration shaker testing as well as general vibration measurements where mass is less of an issue.

Specification	Metric	Imperial
Sensitivity	1.02mV/(m/s ²)	10mV/g
Measurement Range (pk)	±4900m/s ²	±500g
Frequency Range ±10%	1 to 8000 Hz	
Resonant Frequency	≥30 kHz	
Non-Linearity	≤1 %	
Transverse Sensitivity	≤5 %	
Electrical Noise Floor	0.01m/s ² rms	0.001g rms
Overload Limit (Shock)	±49000(m/s ²)pk	±5000gpk
Operating Temp. Range	-55 to +125°C	-67 to +257°F
Polarity ↑	Positive	
Compliance Voltage (Supply)	+18 to +28 VDC	
Current range	2 – 10mA	
Output Bias Voltage	11VDC ± 1.5VDC	
Output Impedance	≤100Ω	
Size (excluding connector)	11mmA/Fx16 mm	0.43"A/Fx0.63"
Weight	5.8gm	0.204oz
Sensing Geometry	Shear	
Sensing Element Material	PZT-5	
Case Material	Titanium	
Connector Position	Side	
Case sealing	Hermetic	
Electrical Connection Type	10-32UNF Microdot	
Mounting	10-32UNF Tapped base for stud mount	

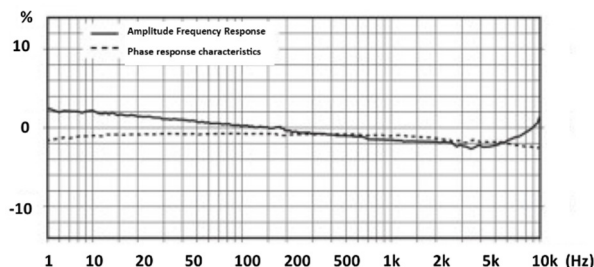
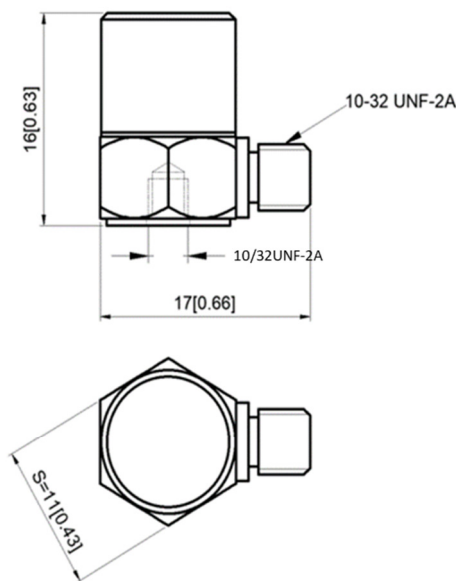

Kemo has a range of cable assemblies available for use with the GV10S-T and other IEPE accelerometers.

1B2-30 – 3m(10ft) 10/32UNF microdot to BNC plug
 1B2-50 – 5m(15ft) 10/32UNF microdot to BNC plug
 1B1-30 – 3m(10ft) 10/32UNFmdot to 10/32UNFmdot
 1B1-50 – 5m(15ft) 10/32UNFmdot to 10/32UNFmdot

Kemo Limited

First Floor, 33 King Street, Theford, Norfolk, IP24 2AW, United Kingdom
 +44 (0)1474 705168

www.kemo.com sales@kemo.com