

- Screened coaxial Kemo KNCAB3 cable (RG174)
- PVC Jacket
- -40°C to +85°C range
- Ideal for extension cables
- Ideal for Voltage signals/IEPE Hammers/Microphones
- Black jacket colour
- Nominal diameter 2.8mm
- BNC Plug to BNC Plug
- Length 1m±5%

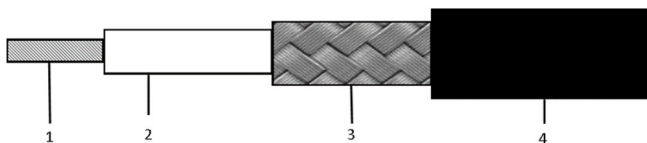

BNC Plug	
Electrical	Value
Impedance	50Ω
Frequency Range	0 ~ 3GHz
Working Voltage (max.)	500V max
Withstand Voltage	1500Vrms
Insulation Resistance	≥5000MΩ
VSWR (Voltage Standing Wave Ratio)	≤1.22
Physical	
Body	Nickel Plated Brass
Centre Conductor	Gold plated brass
Insulator	PTFE
Crimping body	Nickel plated copper alloy
Temperature Range	-55°C to +155°C
Durability	>500 connections

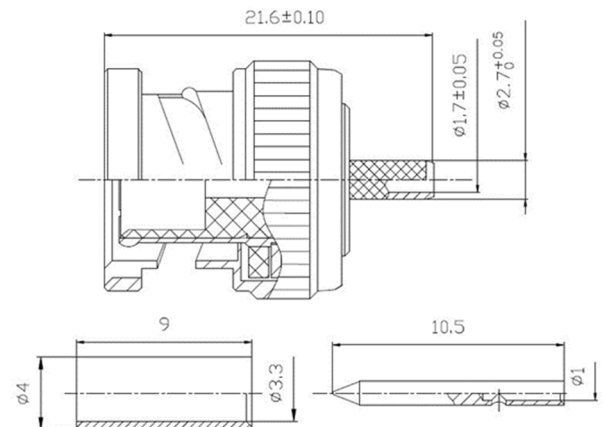

Cable Electrical Properties	Value
Impedance	50 ±2Ω
Nom. Capacitance	101pF/m
Voltage rating	1500Vrms
Max. Attenuation	125dB/100m @1GHz
Temp rating	-40°C to +85°C
Min Bending radius	Fixed: 10mm
Min Bending radius	Flexing: 20mm

Layer	Description	Material	Overall diameter
1	Central conductor – multi strand	Bare Copper (7/0.16mm)	0.30mm
2	Dielectric/Insulation	PTFE	1.52mm ±0.08mm
3	Screen/Outer conductor	Tinned Copper Braid 90% coverage	2mm ±0.1mm
4	Outer jacket	PVC	2.8mm ±0.13mm

Due to continued product development Kemo Limited reserve the right to change specification without notice.

### Kemo Limited

First Floor, 33 King Street, Thetford, Norfolk, IP24 2AW, United Kingdom

+44 (0)1474 705168

[www.kemo.com](http://www.kemo.com) [sales@kemo.com](mailto:sales@kemo.com)