

- Miniature cube IEPE Accelerometer
- Shear design
- Piezoelectric ceramic PZT-5
- Sensitivity – 10mV/g
- Mass – 3.9grams
- 10/32UNF side entry connector
- Tapped base mount

The MV10S-T is a miniature monoaxial IEPE accelerometer with a side entry 10/32UNF microdot connector and a tapped base for stud mounting. The low mass and standard microdot connector allow for the use of standard cables but reduced mass loading. Featuring a shear design PZT-5 sensing element the MV10S-T provides high accuracy with wide bandwidth up to 10kHz

Specification	Metric	Imperial
Sensitivity	1.02mV/(m/s ²)	10mV/g
Measurement Range (pk)	±4900m/s ²	±500g
Frequency Range ±10%	1 to 10000 Hz	
Resonant Frequency	≥40 kHz	
Non-Linearity	≤1 %	
Transverse Sensitivity	≤5 %	
Electrical Noise Floor	0.01m/s ² rms	0.001g rms
Overload Limit (Shock)	±49000(m/s ²)pk	±5000gpk
Operating Temp. Range	-55 to +125°C	-67 to +257°F
Polarity ↑	Positive	
Compliance Voltage (Supply)	+18 to +28 VDC	
Current range	2 – 10mA	
Output Bias Voltage	11VDC ± 1.5VDC	
Size (excluding connector)	11x13mm	0.43"x0.51"
Weight	3.9gm	0.138oz
Sensing Geometry	Shear	
Sensing Element Material	PZT-5	
Case Material	Titanium	
Connector Position	Side	
Case sealing	Hermetic	
Electrical Connection Type	10/32UNF Microdot	
Mounting	5-40UNC tapped base	

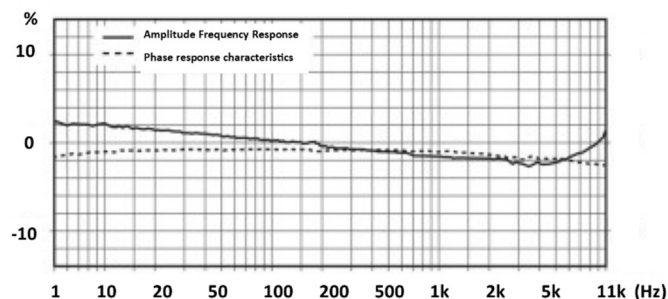
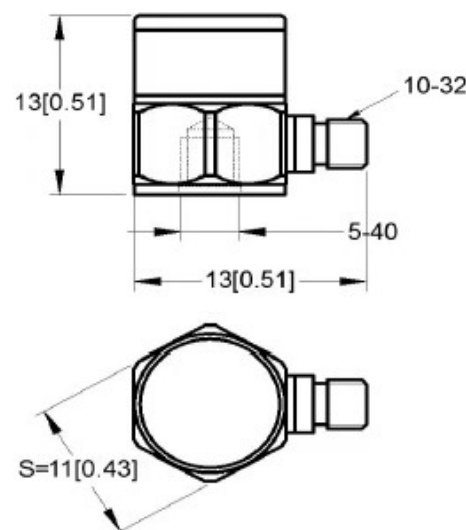

Kemo has a range of cable assemblies available for use with the MV10S-T and other IEPE accelerometers.

- 1B2-30 – 3m(10ft) 10/32UNF microdot to BNC plug
- 1B2-50 – 5m(15ft) 10/32UNF microdot to BNC plug
- 1B1-30 – 3m(10ft) 10/32UNF mdot to 10/32UNFmdot
- 1B1-50 – 5m(15ft) 10/32UNF mdot to 10/32UNFmdot

Kemo Limited

Unit 1, Dene Yard
Green Street Green Road,
Dartford, Kent. DA2 8DH

www.kemo.com sales@kemo.com