

- General Purpose Piezoelectric Triaxial Accelerometer
- Shear design
- Piezoelectric ceramic PZT-5
- Sensitivity – 20pC/g
- Mass – 22grams
- 3 x 10-32UNF connectors
- Use with a Low noise cable

The GCT20-H is a general purpose Triaxial piezoelectric accelerometer with three side entry 10/32UNF microdot connectors all exiting in the same direction. The accelerometer has two through holes for mounting via studs. Featuring a shear design PZT-5 sensing element the GCT20-H provides high accuracy up to 8kHz

Specification	Metric	Imperial
Sensitivity	2.04pC/(m/s ²)	20pC/g
Measurement Range (pk)	±9800m/s ²	±1000g
Frequency Range ±10%	8000 Hz	
Resonant Frequency	≥20 kHz	
Non-Linearity	≤1 %	
Transverse Sensitivity	≤5 %	
Overload Limit (Shock)	±29400(m/s ²)pk	±3000gpk
Operating Temp. Range	-55 to +150°C	-65 to +302°F
Polarity ↑	Positive	
Capacitance	500 pF	
Isolation Impedance	≥100GΩ	
Size (excluding connector)	27.4 x 22 x13 mm	1.07" x 0.93" x0.51"
Weight	22gm	0.78oz
Sensing Geometry	Shear	
Sensing Element Material	PZT-5	
Case Material	Titanium	
Connector Position	Side	
Case sealing	Welded	
Electrical Connection Type	3 x 10-32UNF Microdot	
Mounting	2 x Ø4mm through hole	

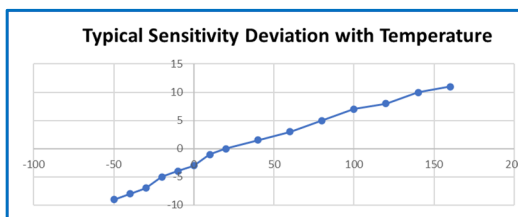
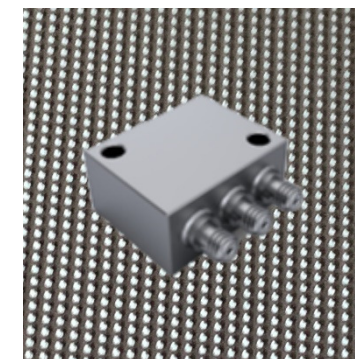
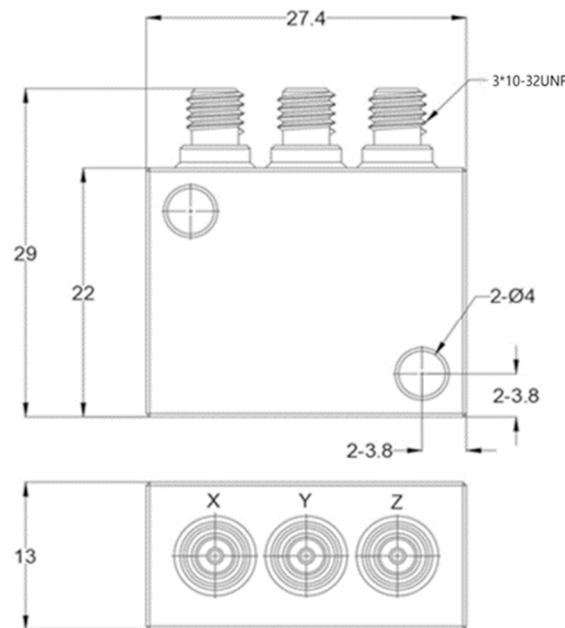

It is recommended that the GCT20-H is used with a low noise cable from Kemo's range to reduce triboelectric noise.

- 1A2-30 – 3m(10ft) 10/32UNF microdot to BNC plug
- 1A2-50 – 5m(15ft) 10/32UNF microdot to BNC plug
- 1A1-30 – 3m(10ft) 10/32UNFmdot to 10/32UNFmdot
- 1A1-50 – 5m(15ft) 10/32UNFmdot to 10/32UNFmdot